

HOSE MASTER

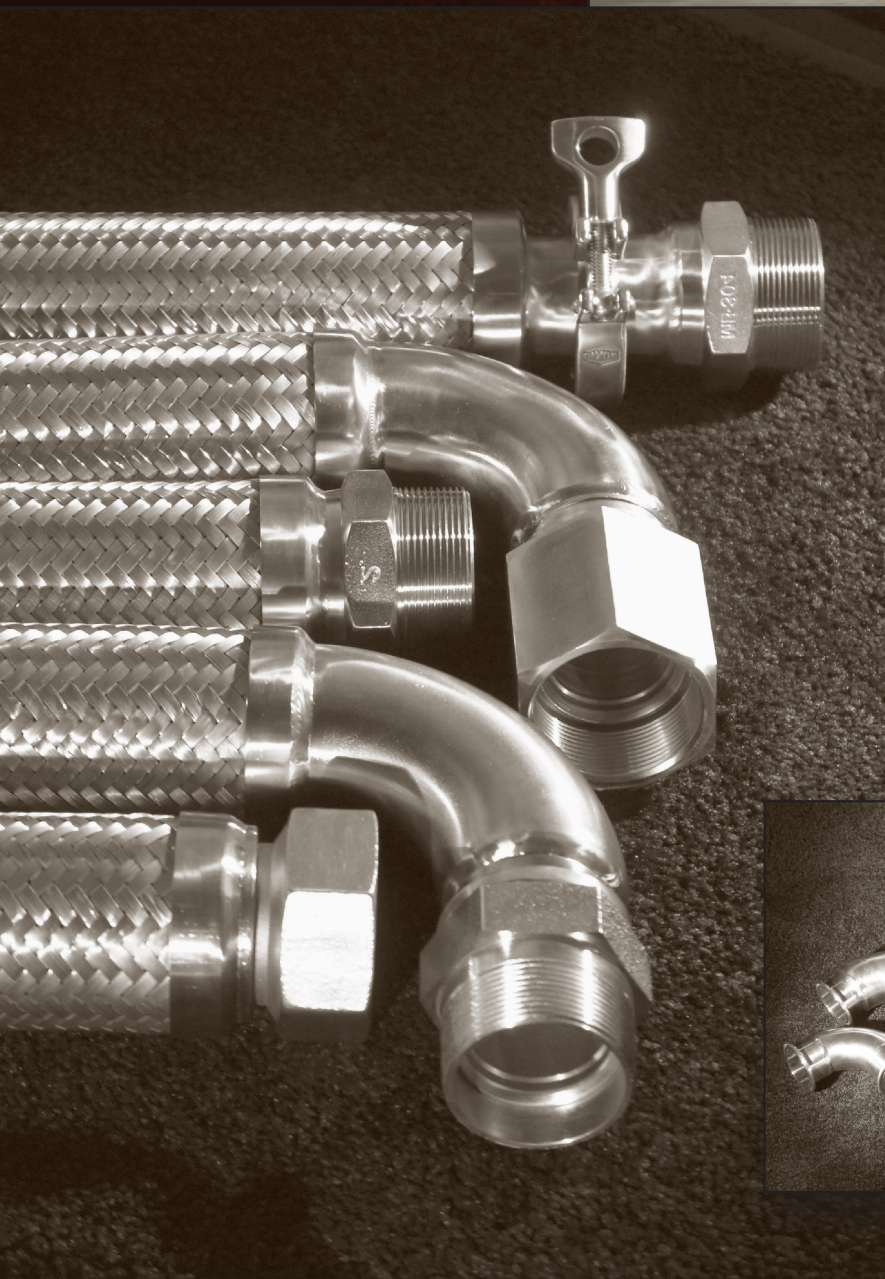

*An Engineering-Driven
Manufacturer Providing
Premier Service and
Innovative Flex Connector
Solutions for the PEI Industry*



Our Company



Hose Master is North America's leading manufacturer of flexible metal hose connectors, with the industry's largest in-house fabricating footprint — over 400,000 square feet of manufacturing space in Cleveland, Ohio; Houston, Texas; Atlanta, Georgia; and Reno, Nevada.

Recognized for technical expertise and innovation, 10% of Hose Master's workforce is dedicated to research and development — providing continuous improvements to our wide range of products.

With a team of ASME IX Certified welders and a comprehensive material stocking program, Hose Master provides exceptional service and the industry's best lead time for flexible connectors.



Having the capacity to design and build state-of-the-art production equipment in its own in-house machine shop, Hose Master is unique in its ability to implement a solution from initial concept to completion.

- Technical and Engineering Center
- Forensic Laboratory
- Engineer and Research & Development Specialists
- 90+ ASME IX Welders
- Total Quality Control
- 100% factory testing of all products before shipping



Table of Contents

Why Buy Hose Master?	Page 2
Hydroforming Process	Page 3
Industry Standard	Page 4
Standard FireShield Products	Pages 5-6
FireShield QuickClamp Assemblies	Page 7
FireShield QuickClamp Components	Page 8
FireShield Hose Specifications	Page 9
Fitting Specifications	Page 9
DEF Flex Connectors	Page 10
FireShield Do's & Don'ts	Page 11-12
Technical Information	Page 13

Why Buy Hose Master?

Major Oil Companies Request Hose Master

- Hose Master has the resources to guarantee our product performance.
- As the manufacturer of the core of the assembly (*the corrugated metal hose and braid*), we control and certify the origins of all raw materials.
- Our engineering team can design and custom-build connectors for any application.
- We have the most comprehensive Research & Development laboratory in the business; we guarantee product integrity, and we stand behind every connector we make.

Distributors Rely on Hose Master

- Standard FireShield and QuickClamp connectors and accessories are stocked and ready to ship within 24 hours.
- Custom-built connectors and prototypes are available for unique applications.
- National sales support from a professional team of PEI (Petroleum Equipment Institute) salespeople.
- Customer Service technical support team and industry's leading engineers are always available to assist with any product question or request.

Installers Prefer Hose Master

- Connectors are highly flexible for easy installation.
- Hose Master offers ongoing installer training programs.
- Products are designed to meet or exceed stringent governmental regulations and agency requirements.
- Hose Master's Customer Service and industry specialists are prepared to offer step-by-step assistance with any industry application.
- 100% testing in our factory of all connectors ensures product integrity and eliminates the need for warranty service repairs.

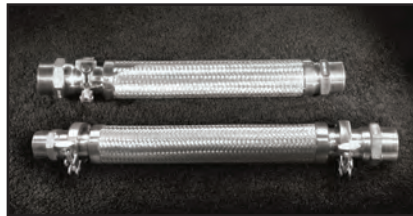

Hose Master is specified by and sells to PEI Distributors throughout the United States. Some of the companies using Hose Master connectors include:

BP
Exxon Mobil
Conoco Phillips
Hess Corporation
Chevron
Shell Oil
Valero
Tesoro
Sunoco
Canadian Tire
Petro-Canada
Federated Co-Op
7-Eleven
Speedway
Marathon
Race Trac
Casey's General Store
Pilot / Flying J
Sheetz
Getgo/Giant Eagle
Costco
Meijer
Cumberland Farms
QuikTrip Corp.
Wawa
Travel Centers of America
Love's Travel Stops & Country Stores
Murphy's/Wal-Mart/Sam's Club

Along with thousands of independently operated service stations

We Will Do The Design Work For You

Connectors must be properly specified for each installation and all factors must be considered including the stresses and movements to which the connectors will be exposed during use. If you have any questions, call us for technical, engineering and design assistance.

Submittal drawings for FireShield and QuickClamp flex connectors are available for download in IGS and PDF formats from www.hosemaster.com.

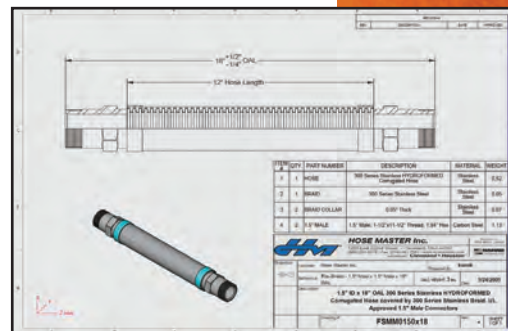

Hydroforming Process

Hose Master's Proprietary Hydroformed Process

Hose Master's proprietary manufacturing process of corrugating metal hose begins with a stainless steel strip that is rolled and the edges welded together to form a thin-walled, gas-tight tube. Hose Master offers:



High quality steel strip



Rolled steel to form a tube



Strong, clean, non-oxidized seam weld

Hose

After the tube has been welded, corrugations are formed into the tube to make it flexible.

Corrugations are formed into the tube either mechanically or hydraulically (Hydroforming).



Annular Profile
Independent corrugations,
straight and parallel

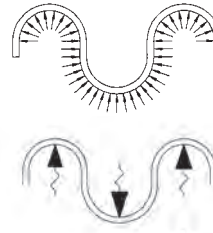

Hydroformed
Evenly distributed stresses

Mechanically Formed
Concentrated stresses

Hydroforming enhances flexibility and cycle life, maintains wall thickness, reduces concentrated residual stress, and minimizes work hardening. Hydroforming is a clean process, using water to form the corrugations, while most other processes require lubrication which can contaminate the product being transferred.

Braid Coverage

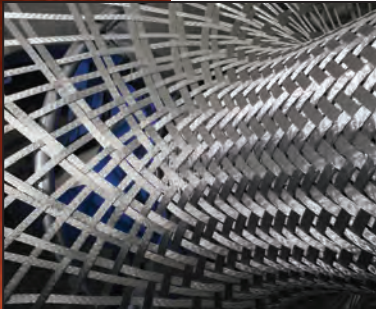

Hose Master's stainless steel wire braid gives corrugated hose the ability to withstand pressure. For increased safety, Hose Master machines the braid directly onto the hose, ensuring that the braid fits tightly against the hose to prevent the potential for hose deformation or squirm. Hose Master offers the highest percentage of braid coverage (90%) yielding better cycle life and protection against damage to the hose.

Fabricating



Hose Master is the leading authority in metal hose fabricating techniques, research, and development. With more than 80 ASME IX certified welders and 50 weld stations, a state-of-the-art forensic laboratory, and team of product specialists, Hose Master guarantees the quality and performance of all its flex connectors.

Hose Master's FireShield Flex Connectors are the Industry Standard

- FireShield connectors meet and exceed specifications for:
 - UL-Listed above-ground piping applications
 - UL-Listed underground piping applications
 - NFPA's Uniform Fire Codes
 - Full vacuum rated
- FireShield products are UL-Listed up to 12 ft.
- Hose Master's proprietary hydroforming process increases flexibility and service life.
- Proprietary tube seam weld technology resists aromatic vapor permeation, while the company's ASME IX certified welders ensure the strongest fitting attachments.
- Extensive zinc-plated and stainless steel end fitting options ensure quick and cost-effective solutions for connecting fiberglass or flexible pipe to the submersible pump and shear valve.
- FireShield connectors minimize threaded connections, resulting in:
 - Fewer leak points
 - Reduced installation time and labor
- Connectors are designed to accept approved secondary containment systems.

24 Hour Shipping

Hose Master offers 24-hour shipping on standard FireShield and QuickClamp connectors. These products are stocked in both our Cleveland, Ohio and Houston, Texas locations. For immediate delivery contact Hose Master's Customer Service department.

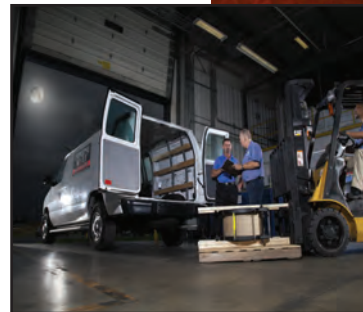

On-Site Training

Hose Master offers on-site installer training and certification. If you would like more information on Hose Master's flexible connector training and certification programs, please contact Hose Master's Customer Service Department at 800-221-2319



Standard FireShield Products



FSMM - Male x Male

Hose Diam. (in.)	Working Pressure (p.s.i.)	Minimum Bend Radius (inches)	Standard Lengths (inches)
*3/4	150	1-3/4	12, 15, 18, 24, 30
*1	150	4	12, 15, 18, 24, 30
*1-1/2	150	4-1/2	12, 15, 18, 24, 30
*2	150	6	12, 15, 18, 24, 30
3	150	9	12, 15, 18, 24, 30



FSM2M - 1-1/2" Male x 2" Male

Hose Diam. (in.)	Working Pressure (p.s.i.)	Minimum Bend Radius (inches)	Standard Lengths (inches)
*1-1/2	150	4-1/2	12, 15, 18, 24, 30

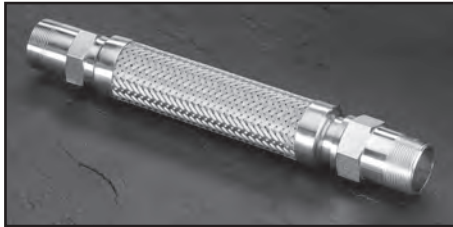

FSMS - Male x Male Swivel

Hose Diam. (in.)	Working Pressure (p.s.i.)	Minimum Bend Radius (inches)	Standard Lengths (inches)
1-1/2	50	4-1/2	12, 15, 18, 24, 30
2	50	6	12, 15, 18, 24, 30

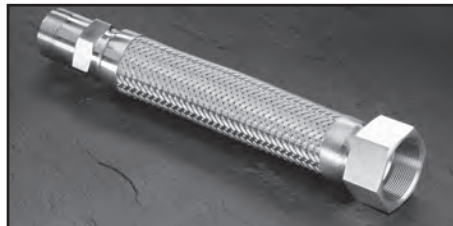

FSMF - Male x 2" Female

Hose Diam. (in.)	Working Pressure (p.s.i.)	Minimum Bend Radius (inches)	Standard Lengths (inches)
*1-1/2	150	4-1/2	12, 15, 18, 24, 30
*2	150	6	12, 15, 18, 24, 30



FSFS - 2" Female x Male Swivel

Hose Diam. (in.)	Working Pressure (p.s.i.)	Minimum Bend Radius (inches)	Standard Lengths (inches)
1-1/2	50	4-1/2	12, 15, 18, 24, 30
2	50	6	12, 15, 18, 24, 30

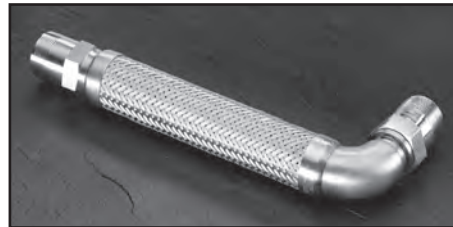

FSMSE - Male x 90° Male Swivel

Hose Diam. (in.)	Working Pressure (p.s.i.)	Minimum Bend Radius (inches)	Standard Lengths (inches)
1-1/2	50	4-1/2	12, 15, 18, 24, 30
2	50	6	12, 15, 18, 24, 30



Swivel Adaptor - ACSWA

Plated swivel adaptor converts the integral hex male to a swivel end. This unique adapter creates a positive metal-to-metal seal when used with Hose Master's exclusive 30° chamfered hex male fitting. This swivel adaptor facilitates installation and is only compatible with Hose Master's FireShield connectors.



Anode - ACANO

Underground connectors used with our anode comply with EPA regulations for buried metal components. Our easily monitored system also meets NACE RP-01-69 standards for cathodic protection.

Standard FireShield Products

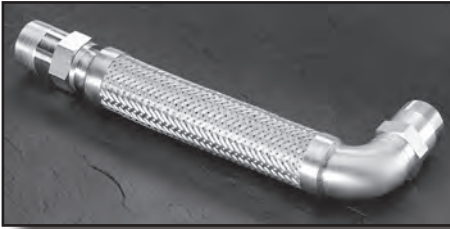

FSSME - Male Swivel x 90° Male

Hose Diam. (in.)	Working Pressure (p.s.i.)	Minimum Bend Radius (inches)	Standard Lengths (inches)
1-1/2	50	4-1/2	12, 15, 18, 24, 30
2	50	6	12, 15, 18, 24, 30



FSSSE - Male Swivel x 90° Male Swivel

Hose Diam. (in.)	Working Pressure (p.s.i.)	Minimum Bend Radius (inches)	Standard Lengths (inches)
1-1/2	50	4-1/2	12, 15, 18, 24, 30
2	50	6	12, 15, 18, 24, 30

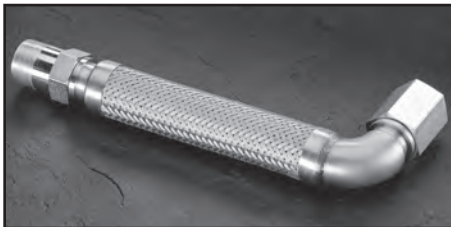

FSSWE - Male Swivel x 90° Female Swivel

Hose Diam. (in.)	Working Pressure (p.s.i.)	Minimum Bend Radius (inches)	Standard Lengths (inches)
1-1/2	50	4-1/2	12, 15, 18, 24, 30
2	50	6	12, 15, 18, 24, 30

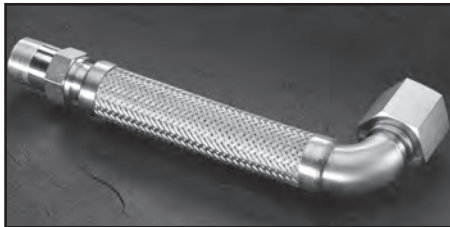

FSS2WE - Male Swivel x 2" 90° Female Swivel

Hose Diam. (in.)	Working Pressure (p.s.i.)	Minimum Bend Radius (inches)	Standard Lengths (inches)
1-1/2	50	4-1/2	12, 15, 18, 24, 30



FSMU - Male x Union

Hose Diam. (in.)	Working Pressure (p.s.i.)	Minimum Bend Radius (inches)	Standard Lengths (inches)
*3	50	9	12, 15, 18, 24, 30



FSUU - Union x Union

Hose Diam. (in.)	Working Pressure (p.s.i.)	Minimum Bend Radius (inches)	Standard Lengths (inches)
*3	50	9	12, 15, 18, 24, 30

* Flex connectors available with 100% stainless steel construction for even wider compatibility with evolving fuel blends. Customers may indicate their preference for a 100% stainless flex connector for qualifying constructions by adding a "-SS" suffix to the part number.

FireShield QuickClamp Assemblies

FireShield QuickClamp assemblies make tight flex connector installations as easy as possible. Offered with a multitude of end connections (including FRP fittings) and custom hose lengths, FireShield QuickClamp assemblies offer installers the ability to fasten one or both ends of a connector within a piping system with minimal use of tools - eliminating timely labor costs and increasing profits.

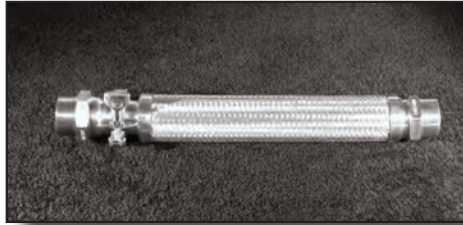

FSQM - Hex Male x QuickClamp Hex Male

Hose Diam. (in.)	Working Pressure (p.s.i.)	Minimum Bend Radius (inches)	Standard Lengths (inches)
1-1/2	50	4-1/2	18, 24, 30
2	50	6	18, 24, 30
3*	50	9	18, 24, 30

*features carbon steel male and hex wrench pad

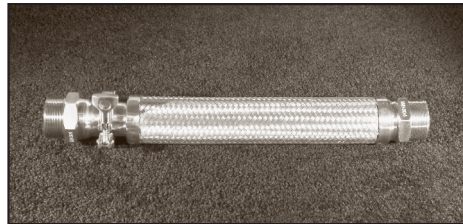

FSQ2M - 2" Male x QuickClamp Hex Male

Hose Diam. (in.)	Working Pressure (p.s.i.)	Minimum Bend Radius (inches)	Standard Lengths (inches)
1-1/2	50	4-1/2	18, 24, 30

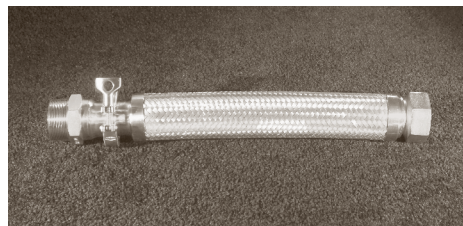

FSQF - 2" Female x QuickClamp Hex Male

Hose Diam. (in.)	Working Pressure (p.s.i.)	Minimum Bend Radius (inches)	Standard Lengths (inches)
1-1/2	50	4-1/2	18, 24, 30

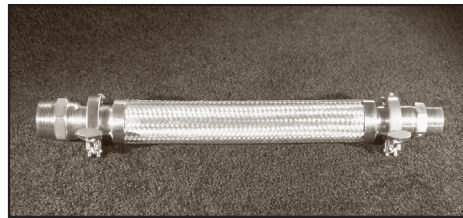

FSQQ - QuickClamp Hex Male x QuickClamp Hex Male

Hose Diam. (in.)	Working Pressure (p.s.i.)	Minimum Bend Radius (inches)	Standard Lengths (inches)
1-1/2	50	4-1/2	18, 24, 30
2	50	6	18, 24, 30
3	50	9	18, 24, 30

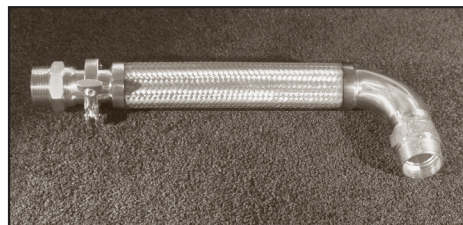

FSQSE - 90° Male Swivel x QuickClamp Hex Male

Hose Diam. (in.)	Working Pressure (p.s.i.)	Minimum Bend Radius (inches)	Standard Lengths (inches)
1-1/2	50	4-1/2	18, 24, 30
2	50	6	18, 24, 30

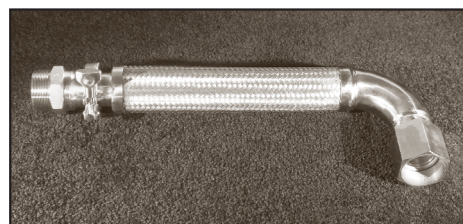

FSQWE - 90° Female Swivel x QuickClamp Hex Male

Hose Diam. (in.)	Working Pressure (p.s.i.)	Minimum Bend Radius (inches)	Standard Lengths (inches)
1-1/2	50	4-1/2	18, 24, 30
2	50	6	18, 24, 30

- ACQSeal & ACQClamp are included with all FireShield QuickClamp assembly styles
- Overall length is measured from end to end including QuickClamp adapter

FireShield QuickClamp Components

In addition to standard QuickClamp flex connectors, Hose Master offers accessory components to easily interchange and install flex connectors with a variety of end connection options.

QuickClamp accessory items feature a stainless steel construction ensuring compatibility with the widest range of fuels including gasoline, gasoline-ethanol blends, ethanol, diesel, and biofuels.

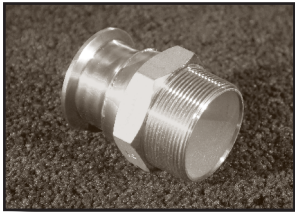

ACQM
Hex Male
Available Sizes:
1-1/2, 2, & 3"

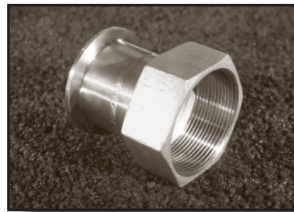

ACQF
Hex Female
Available Sizes:
2"



ACQME
90° Male
Available Sizes:
1-1/2 & 2"



ACQFE
90° Female
Available Sizes:
2"



ACQQE
90° Flange
Available Sizes:
2 & 3"



ACQQEFF
90° Full-Flow
Flange
Available Sizes:
2"



ACQG
Female Glue Pipe
Available Sizes:
2 & 3"



ACQGE
90° Female Glue
Pipe
Available Sizes:
2 & 3"



ACQClamp
Clamp
Available
Sizes:
1-1/2, 2, & 3



ACQSeal
Viton Seal



ACQCap
Cap
Available Sizes:
2 & 3"

A mainstay of Hose Master's continued success is a focus on intelligent, customer-driven solutions. Recognizing off-the-shelf products are not always a practical solution for unique service station specifications, Hose Master's UL-listing allows for any combination of approved end connections and flexible hose lengths, up to 12 feet long, to best suit your application.

For assistance in configuring your site-specific flex connector assembly options, contact our Inside Sales Department for technical support.

FireShield Hose Specifications

FireShield UL/ULC Hose Specifications							
Hose Diameter (inches)	Number of Braids (#)	Braid Alloy	Hose Material	UL Standards		Minimum Bend Radius (inches)**	Minimum Length for 90° Bend (inches)
				Working Pressure (p.s.i.)*	Burst Pressure (p.s.i.)		
3/4	1	300 Series Stainless	300 Series Stainless	150	600	1.7	12
1	1	300 Series Stainless	300 Series Stainless	150	600	4.0	16
1 1/2	1	300 Series Stainless	300 Series Stainless	150	600	4.5	18
2	1	300 Series Stainless	300 Series Stainless	150	600	6.0	24
3	1	300 Series Stainless	300 Series Stainless	150	600	9.0	28

* The working pressure is rated at ambient temperatures. Working pressure changes to 50 psi when using a FireShield integral hex swivel fitting or QuickClamp coupling.

** The minimum bend radius is measured from the centerline of the hose.

Fitting Specifications

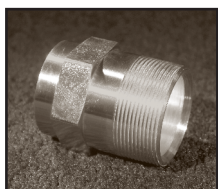

Hex Male - Carbon Steel

Size (in.)	Thread Size (in.)	Hex Size (in.)
1 1/2	1 1/2 x 11 1/2	1.94
2	2 x 11 1/2	2.38
3	3 x 8	4.00

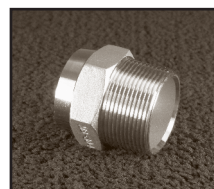

Hex Male - Stainless Steel

Size (in.)	Thread Size (in.)	Hex Size (in.)
3/4	3/4 x 14	1.06
1	1 x 11 1/2	1.38
1 1/2	1 1/2 x 11 1/2	2.00
2	2 x 11 1/2	2.50



Hex Female - Carbon Steel

Size (in.)	Thread Size (in.)	Hex Size (in.)
2	2 x 11 1/2	2.63



Hex Female - Stainless Steel

Size (in.)	Thread Size (in.)	Hex Size (in.)
2	2 x 11 1/2	2.61

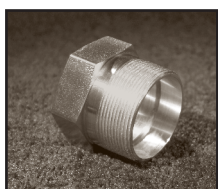

Male Swivel - Carbon Steel

Size (in.)	Thread Size (in.)	Hex Size (in.)
1 1/2	1 1/2 x 11 1/2	1.94
2	2 x 11 1/2	2.38



Female Swivel - Carbon Steel

Size (in.)	Thread Size (in.)	Hex Size (in.)
1 1/2	1 1/2 x 11 1/2	1.94
2	2 x 11 1/2	2.38

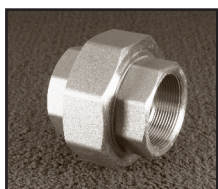

Female Union - Carbon Steel

Size (in.)	Thread Size (in.)	Hex Size (in.)
3	3 x 8	5.75



Female Union - Stainless Steel

Size (in.)	Thread Size (in.)	Hex Size (in.)
3/4	3/4 x 14	2.31
1	1 x 11 1/2	2.42
1 1/2	1 1/2 x 11 1/2	3.00
2	2 x 11 1/2	3.50

Designated Service

■ FireShield Flex Connectors

■ DEF Flex Connectors

■ Allowable for Both

800-221-2319 • www.hosemaster.com

DEF Flex Connectors are designed and manufactured to meet the specific corrosive environments encountered when transferring Diesel Exhaust Fluid (DEF).

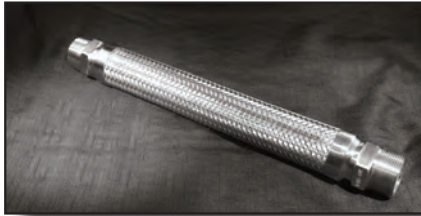

Stainless Steel Hex Males Each End

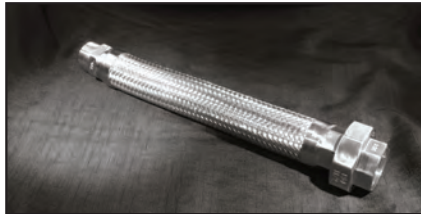

Stainless Steel Hex Male x Stainless Steel Female Union

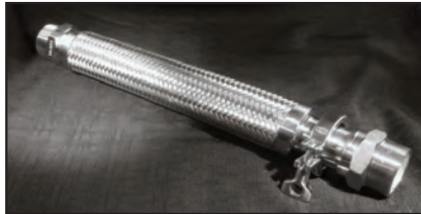

Stainless Steel Hex Male x Stainless Steel Hex Male QuickClamp

Hose Master DEF Flex Connectors Feature

- 100% stainless steel construction for optimal corrosion resistance
- Proprietary tube seam weld technology resists oxidation
- Strongest fitting attachments ensured by ASME IX certified welders
- Increased flexibility and service life from Hose Master's proprietary hydroforming process
- Available in styles as shown left, or with a variety of industrial stainless steel fitting options. Please consult Hose Master inside sales for details
- Connectors are also available in QuickClamp designs (shown left) and include stainless clamp with special peroxide-cured EPDM gasket*

DEF Flex Connector Specifications

Hose Diameter (in.)	Maximum Working Pressure Hex Males e/e (p.s.i.)	Maximum Working Pressure Hex Male x 150# Hex Female Union (p.s.i.)	Maximum Working Pressure Hex Male x Hex Male QuickClamp (p.s.i.)	Minimum Connector Bend Radius (in.)	Standard Connector Lengths (in.)
3/4	898	300	50	2.1	12, 18, 24
1	718	300	50	2.7	12, 18, 24
1 1/2	531	300	50	3.9	12, 18, 24
2	449	300	50	5.1	12, 18, 24

- Other sizes, lengths and stainless end connections are available upon request.
- FireShield connectors are not recommended for DEF service and do not carry UL-approval for that application

DEF Flex Connector Applications

- Mobile skids
- Above ground totes and storage tanks
- Underground storage tanks
- DEF concentrations recognized by ISO 22241-1 and API DEF Certification standards

* Peroxide-cured EPDM gaskets are NOT interchangeable with standard QuickClamp gaskets

Installation Do's & Don'ts

- DO** design the installation to allow for all movement (ground, vibration, etc.) after the installation.
- DO** keep the hose free from all objects and debris.
- DO** measure to ensure proper length of connector has been selected.
- DO** handle and store the connectors carefully before an installation.
- DO** follow all printed instructions included with the connectors.
- DO** note the minimum bend radius as specified.
- DO** install flexible connectors so that the bend is as close to the center of the connector as possible.
- DO** keep the painted lay line straight and on the centerline of the connector.
- DO** use a wrench only on the hex flats.
- DO** use the manufacturer's recommended cathodic protection system or dielectric isolation boot.
- DO** check for leaks before covering the installation.

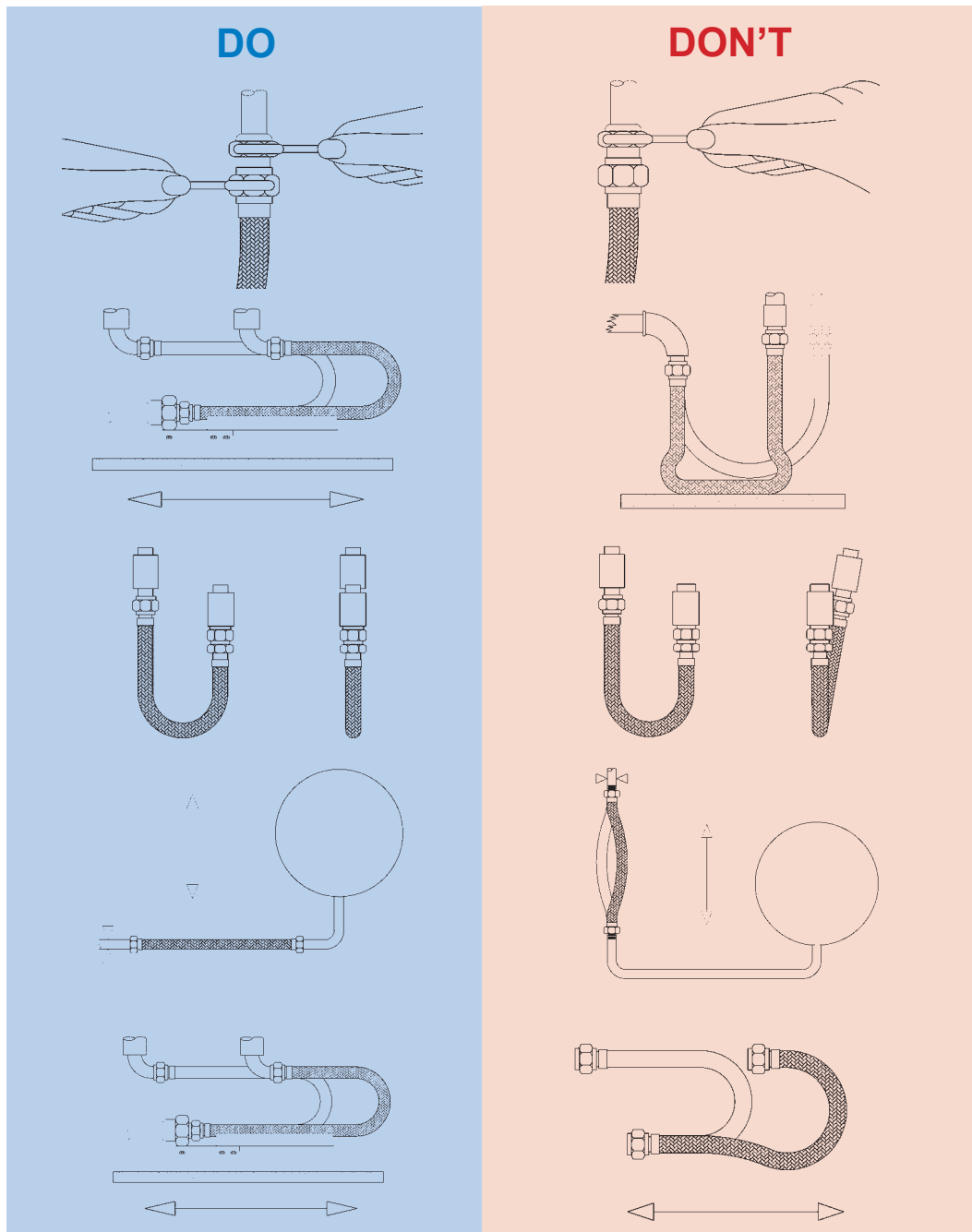

- DON'T** use a wrench or any other tool on the hose or braid collar.
- DON'T** twist or torque the flex connector.
- DON'T** over-bend a flexible connector beyond its minimum bend radius.
- DON'T** install a flexible connector with the bend next to the end fittings.
- DON'T** attempt to stretch or compress a flexible connector to fit an installation, or allow connector to stretch or compress during use.
- DON'T** restrict flexibility by allowing a connector to come into contact with other components or equipment during an installation or during use.
- DON'T** expose connector to damage or corrosives during storage, installation or use. Groundwater, road salt, soil, etc. are or may contain corrosives. If necessary use a cover or boot to protect the connector.
- DON'T** attempt to reuse a flex connector once it has been installed.

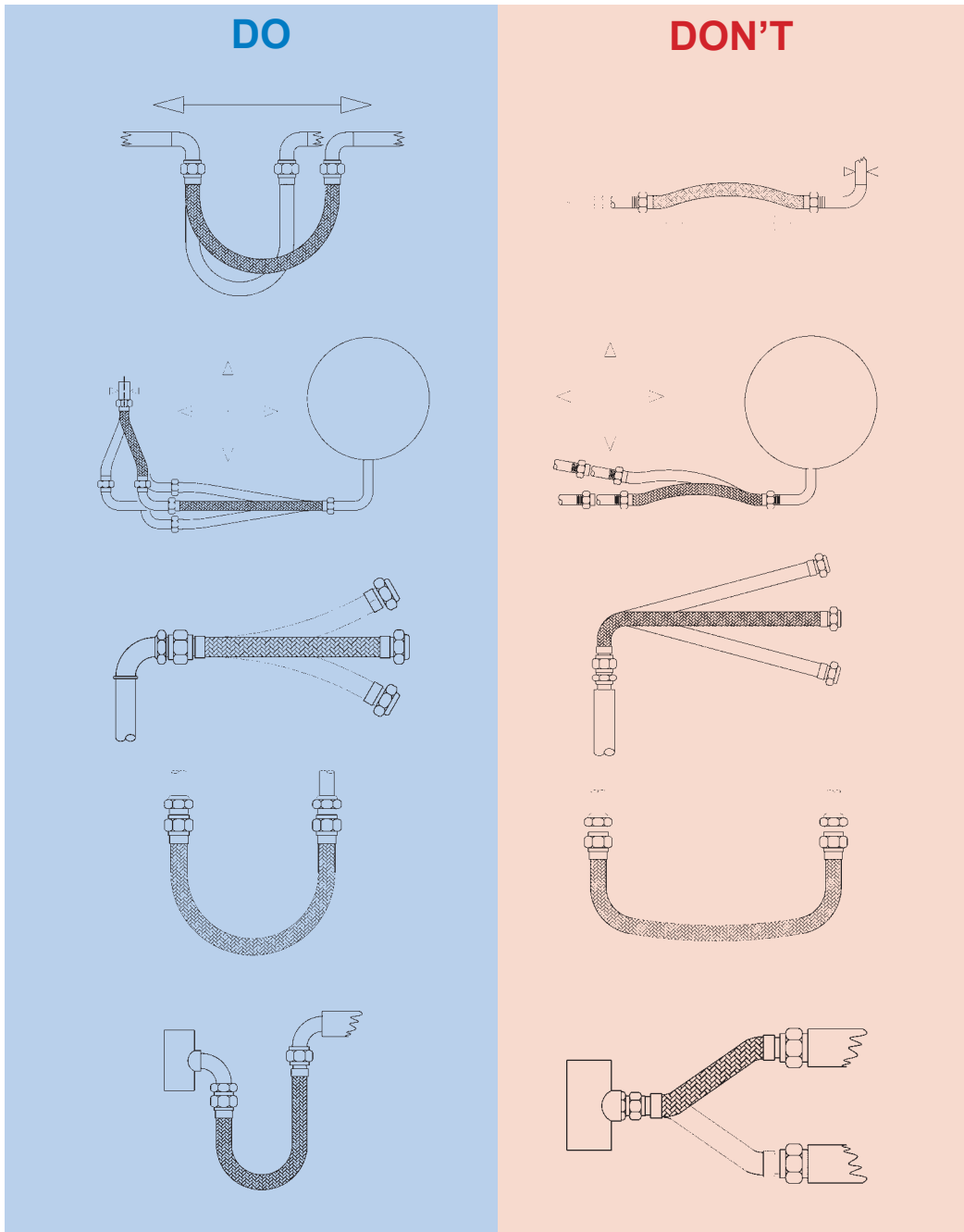

Note: Do's and Don'ts serve as a guideline to facilitate installation. As you design and install your system, refer to the Petroleum Equipment Institute's RP900 UST Inspection and Maintenance Manual, and RP100 Recommended Practices for Installation of Underground Liquid Storage Systems.

LATERAL OFFSET

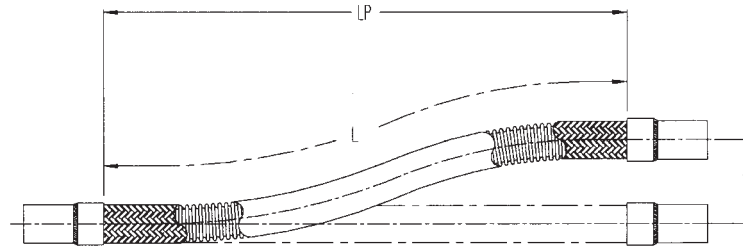

Formula: $L = \sqrt{20R \times T}$ $R = \text{Hose minimum bend radius in this formula}$

$$L_p = \sqrt{L^2 - T^2}$$

ANGULAR DEFLECTION

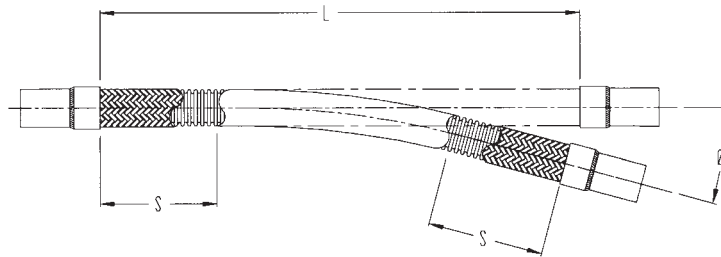

Formula: $L = 2S + (\theta/57.3)R$

$R = \text{Hose minimum bend radius in this formula}$

CIRCLE

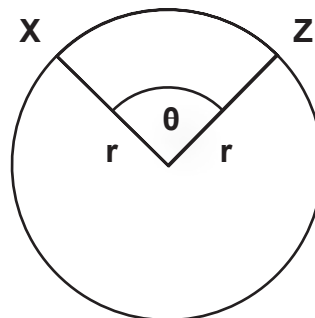

Area = πr^2 Where: $\pi = 3.14$

Circumference = $2\pi r$

Length of Arc XZ = $\theta * (\pi/180) * r$

Additional Locations



Certifications



Canadian
Registration
Number

ASME IX
Certified Welders



PED
Pressure
Equipment
Directive



HOSE MASTER

1233 East 222nd Street • Cleveland, Ohio 44117
(800) 221-2319 • Fax: (216) 481-7557 • www.hosemaster.com
Cleveland • Houston • Atlanta • Reno

ISO 9001
Registered Quality System

